

The 555SE Discrete 555 Timer

– Surface Mount Soldering Kit –



Evil Mad Scientist

Model 20555 emsl.us/922

Assembly Instructions

Kit Contents

This kit includes both electronic and mechanical parts.

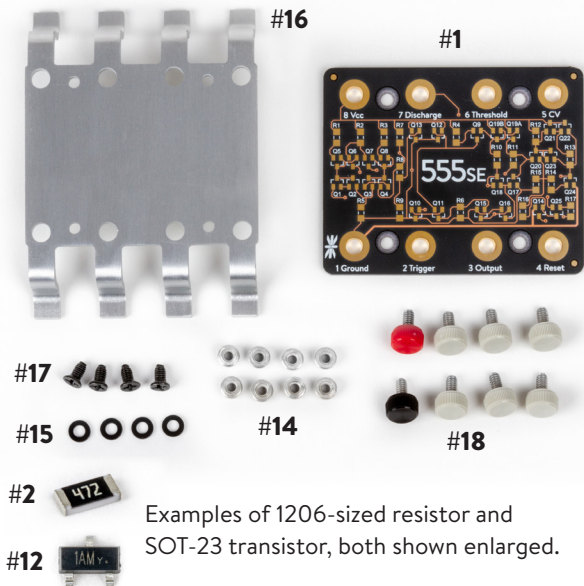

Line	Locations	Description	Qty
1	-	The 555SE Circuit Board (PCB)	1
2	R1, R3, R7-9, R11, R15	4.7 k Ω resistor (1206)	7
3	R2	820 Ω resistor (1206)	1
4	R4	1 k Ω resistor (1206)	1
5	R5	10 k Ω resistor (1206)	1
6	R6, R17	100 k Ω resistor (1206)	2
7	R10	15 k Ω resistor (1206)	1
8	R12	6.8 k Ω resistor (1206)	1
9	R13	3.9 k Ω resistor (1206)	1
10	R14	220 Ω resistor (1206)	1
11	R16	100 Ω resistor (1206)	1
12	Q1-4, Q14-18, Q20-22, Q24	MMBT3904 Transistor (SOT-23)	13
13	Q5-13, Q19 (2), Q23, Q25	MMBT3906 Transistor (SOT-23)	13
14	Pins 1-8	Surface mount nut (4-40)	8
15	Below PCB	Nylon washer	4
16	Below washers	Aluminum Leadframe	1
17	Countersunk holes	Flat head thread-rolling screws	4
18	Pins 1-8; Thumbscrews	6 gray, 1 red, 1 black	8

Required tools and materials

Necessary, but not included with the kit

- Solder.
Recommended: *Either* thin rosin-core (flux-core) solder wire (**A**) or solder paste (**B**).
- A soldering iron (**C**)*
Recommended: A 25 - 50 W iron with a fine tip.
- Metal tweezers for handling small components.
Recommended: Fine-point stainless tweezers (**D**).
- A small Phillips-head screwdriver (**E**).
Recommended: PH #1 size.

Not required, but recommended:

- An extra-fine soldering tip will be helpful. If you are using solder wire, extra fine solder is helpful too.
- This kit contains relatively small parts. Good lighting can be very helpful, and you may wish to work with a magnifier, jeweler's loupe, or microscope.

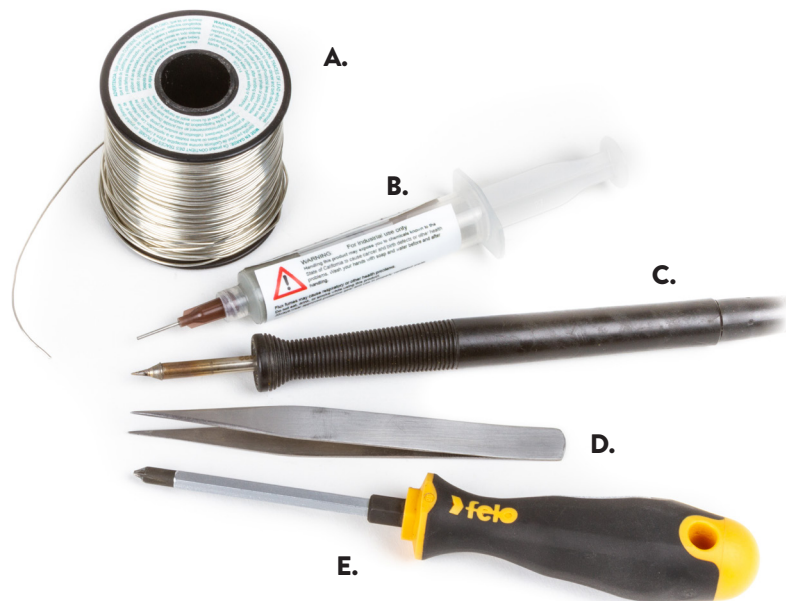

*Special note: If you have moved beyond soldering irons...

Our assembly instructions that follow will employ basic techniques for surface mount assembly with a hand-held soldering iron. But, if you already know and prefer different methods, for example using a hot air rework station, a skillet, a reflow oven, or flux or stencils, *please make use of your skills and equipment as you see fit.*

Assembly Step 1: Install the first resistor

The electrical components are packaged in carrier tape to keep them safe and well labeled. We recommend that you only take components out as you need them, since the labels on the parts can be hard to read.

 The first component is #2, a 4.7 k Ω resistor, which will go in location R1 on the circuit board. (Typical labeling: “472”, meaning 47 followed by two zeros, or 4700 ohms.)

Resistors are symmetric; you can install them facing either way.

If you are using solder wire...

Use your soldering iron to wet a small amount of solder (A) to one pad of location R1. Ideally, this should leave a very slight dome of solder on the pad: Enough to see that it has some thickness, but not enough that it forms a tall blob.

Next, use your tweezers to position the resistor in place, centered between the two pads of R1. Use your soldering iron (B) to melt the solder to both the resistor and pad, thereby “tacking” one end of the resistor in place.



Allow the resistor to cool for a moment, then solder the other end of the resistor in place (C). When you are done, you should have a neat meniscus of solder on both ends of the resistor (D), bonding it neatly in place.

If you are using solder paste...

Dispense a very small amount of solder paste onto each of the pads of R1. Use tweezers to set the 4.7 k Ω resistor into that paste (E). Solder paste is sticky, and that should hold the component lightly in place.

Use the soldering iron to melt the solder on one end of the resistor (F), which will wet to both the pad and resistor. Wait a moment for the resistor to cool, then repeat for the other end of the resistor.

When complete, you should have a neat meniscus of solder on both ends of the resistor (D), bonding it neatly in place. When inspecting the solder joints, double check that all of the paste has been melted and fused together without leaving stray paste behind.

Assembly Step 2: Install the remaining 4.7 k Ω resistors

Following the same procedures laid out in Assembly Step 1, install the remaining six 4.7 k Ω resistors, which go in locations R3, R7 - R9, R11, and R15.

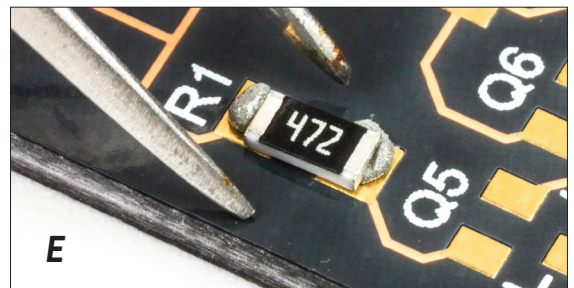
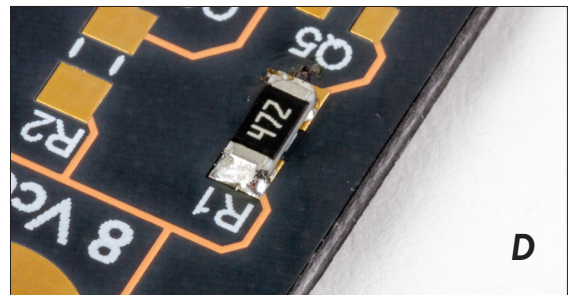
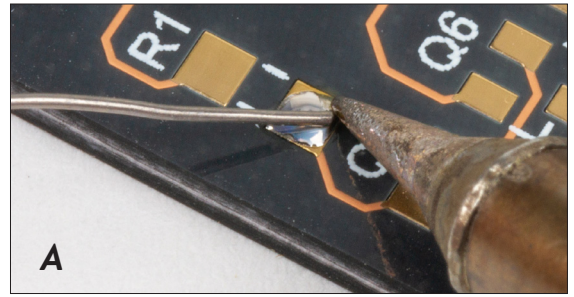

Assembly Step 3: Install the remaining resistors

Continuing to work with the same procedures, install the remaining resistors onto the circuit board.

The locations and values of the resistors are listed in the table here, along with the typical marking labels found on these resistors. Once again, we recommend that you only get the components out as you need them. Tweezers can be helpful when removing components from carrier tape.

Component	Location	Marking	Value
#3	R2	821	820 Ω
#4	R4	102	1 kΩ
#5	R5	103	10 kΩ
#6	R6, R17	104	100 kΩ
#7	R10	153	15 kΩ
#8	R12	682	6.8 kΩ
#9	R13	392	3.9 kΩ
#10	R14	221	220 Ω
#11	R16	101	100 Ω

Assembly Step 4: Install the '3904 transistors



Component #12 is an NPN (bipolar) transistor, type MMBT3904, in a three-pin SOT-23 package. The marking on the package typically reads “1AM”. (Part marking is not guaranteed to be consistent.)

If you are using solder wire, melt a small dot of solder to one of the three pads of location Q1, following along with the method used for resistors. Then, hold the transistor in place with tweezers and solder that first pin to tack the transistor in place (A). Then, solder the other two pins of the transistor.

If you are using solder paste, dispense small dots of solder paste onto the three pads of location Q1, set the transistor in place with tweezers and solder all three pins in place.

Once the first transistor is installed, repeat the procedure and solder the remaining 12 type MMBT3904 transistors into place at locations Q2 - Q4, Q14 - Q18, Q20 - Q22, and Q24.

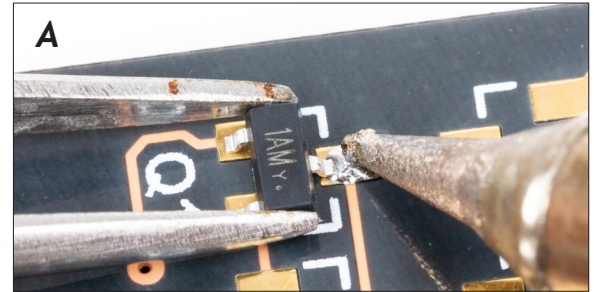

Assembly Step 5: Install the '3906 transistors



Component #13 is a PNP (bipolar) transistor, MMBT3906, in a very similar three-pin SOT-23 package. The marking on the package typically reads “K3N” or “2A”.

Install the 13 MMBT3906 transistors at locations Q5 - Q13, Q19A, Q19B, Q23, and Q25, using the same method used in the previous step for the '3904 transistors.

After finishing this step, the appearance of the circuit board should be as shown here (B), with components soldered into in all of the labeled “R” and “Q” locations on the board.

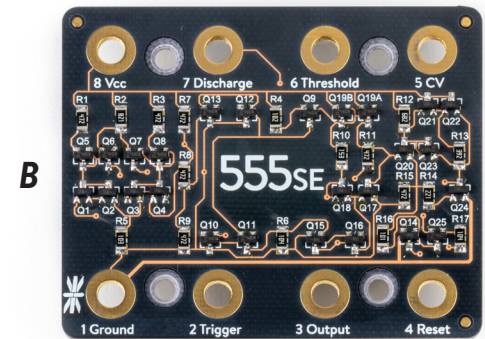

Assembly Step 6: Install the surface mount nuts

Press one of the surface-mount threaded nuts, #14, into the large hole labeled “1 Ground” such that it sits flush in place. (There may be a brown plastic sticker over the top of the nut. If so, remove that sticker.)

Solder the nut into place. If you are using solder wire, heat the nut with your iron for a few seconds, and apply solder to the seam where the nut meets the board (C). If using paste, place a few small beads of it along the seam before heating up the joint. Take care to only apply solder to the outer surface of the nut; keep solder out of the threads.

It is not necessary to create a full fillet of solder between the nut and the board. It is important that the solder gets hot enough that it wicks into the joint, and that solder gets at least most of the way around the circumference (D). **Caution:** The thermal mass of the nut makes it take longer to heat up – and longer to cool down – than other components.

Once you have finished installing this nut at Pin 1, install the remaining seven nuts at Pins 2 - 8, following the same procedure.

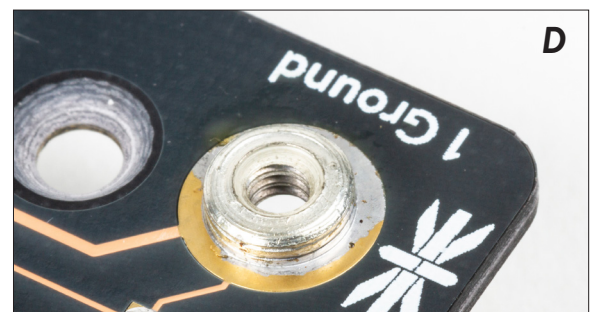

Assembly Step 7: Mount the board to the leadframe

Center the four black nylon washers, part #15, over the four small-diameter holes in the aluminum leadframe (A), part #16.

Place the assembled circuit board over the leadframe, carefully centering the countersunk holes over the nylon washers. The leadframe is symmetric; the circuit board can face either way. Place the four flat-head M3 screws, part #17, into the countersunk holes and tighten them in place with a Phillips #1 screwdriver (B). Tighten all four screws until just firm; do not overtighten them.

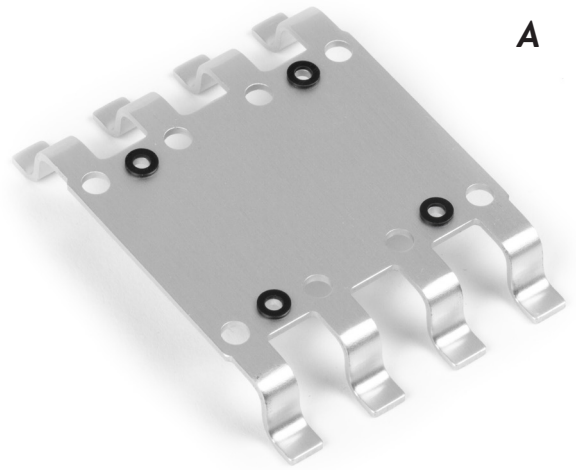

Assembly Step 8 (Last step!): Add the thumbscrews

Thread the eight tiny thumbscrews, part #18, into place (C). Black for Pin 1 (Ground), red for Pin 8 (Vcc), and gray for the six others.

Testing and using your new 555 Timer

You can connect to the 555SE through bare wire, alligator clips, or spade or ring lugs, using the thumbscrew terminal posts (D). You can also directly solder wires to the landing pads around the surface mount nuts.

The decorative leadframe stand is made from anodized aluminum. While nominally an insulator, it can become conductive if scratched or damaged.

Your 555SE timer can be used as a direct substitute for a 555 timer IC in most circuits. See the datasheet for specifications and more information.

Suggested test circuit: 555 LED Blinker

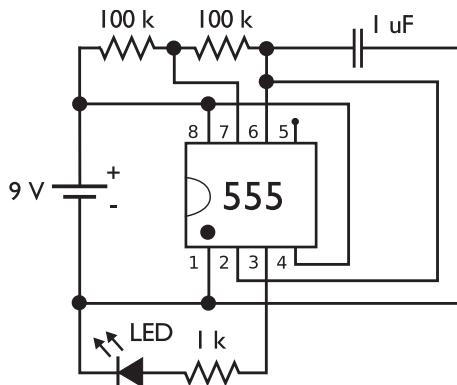

A good site with hundreds of other 555 projects is Talking Electronics: <http://tinyurl.com/555projects>

More information

There is much more to learn about this kit, and you can find it on our documentation site: <https://wiki.evilmadscientist.com/555>

The documentation there includes the datasheet for this kit, giving detailed electrical properties, as well as *The 555 Timer: Principles of Operation*, our in-depth educational guide to what's inside a 555, and how it works down to the transistor level.

